



valentine  One[®]
RADAR LOCATOR

With exclusive computer modes:

- All-Bogeys[®]
- Logic[®]
- Advanced-Logic[®]

The only one with Full Coverage



Contents

page

| | |
|--|---------------|
| Welcome to Full Coverage | |
| Full Coverage..... | 1-2 |
| What's Included | 3 |
| Starting up | 3 |
| What you should know about radar | 4-6 |
| Finding radar — On-the-road situations..... | 7-10 |
| Laser Warning | 11 |
| What you should know about laser | 12 |
| Finding Laser | 13 |
| Controls & Functions..... | 14-16 |
| Mounting — Where & How..... | 17-18 |
| Installation — Direct-wire Power Adapter | 19 |
| Changing the fuse | 19, 22 |
| Power Cords | 20 |
| Installation — Concealed Display..... | 21 |
| Installation — Lighter Adapter, fuse..... | 22-23 |
| Remote Audio Adapter | 24-25 |
| POP..... | 26 |
| Troubleshooting | 27-28 |
| Doubts — Maybe it's not working right | 29 |
| Service | 30 |
| Specifications..... | 31 |
| Parts & Accessories | 31 |
| Warranty | 32 |
| A few things to remember | |



▲ Mike Valentine: Electronics engineer, former president of Cincinnati Microwave, and co-inventor of Escort®

Welcome to Full Coverage

Dear Owner:

When an interest lasts for a year to two, that's a hobby. When it goes on non-stop for more than 25 years, I think it fairly can be called an obsession.

My wife says I'm obsessed with traffic radar. She's right. Radar is out there, skulking (Stalking?) around, hiding in the bushes. And I really get a kick out of finding it, finding it first, finding it every time. This is a civilian version of what the military calls Electronic Warfare Support Measures (ESM). I find it compelling, I can't help it.

I'm pretty good at it too. That makes it more fun. Back in the seventies, Jim Jaeger and I invented Escort. It was the best radar finder on the market for a long time and I enjoyed running the company that made it, Cincinnati Microwave.

Since starting my own company, we've made other products and earned a reputation for innovation. But nothing is quite as much fun for me as finding radar.

V1's legendary reputation is built on what's inside. The magnesium case still looks identical to the original, but the electronics inside have been completely changed time and time again. I believe in continuous improvement. That's what keeps V1's performance ahead of the pack. I don't believe in planned obsolescence. Whenever we make a performance breakthrough, we offer it to past customers as an upgrade. Even the first V1 can be updated to today's protection. See www.valentine1.com for details; you'll also find a wide variety of radar and laser information not available anywhere else.

I hope you enjoy your Valentine One as much as I enjoy mine. Thanks for trusting me to find radar and laser for you.

Sincerely,

Michael D. Valentine
President

What Full Coverage means for you

Finds all radars

Valentine One covers all four bands.

X band most common for moving and stationary; can be used in "Instant-on" mode; this frequency is shared with burglar alarms and door openers.

K band moving and stationary radar; can be used in "Instant-on" mode.

Ka band widest of the radar bands; moving or stationary; can be used in "Instant-on."

Photo radar K or Ka band; stationary only.

POP Protection . . covers POP mode on two bands—specifically the MPH Industries models BEE III and Enforcer on both K and Ka; moving or stationary.

Ku band not used in U.S.; standard equipment on all V1s, but not activated. To activate, see: <http://www.valentine1.com/lab/MikesLabRpt3.asp>.

Euro Mode narrows and intensifies radar coverage, and limits it to K and the sections of Ka bands used in Europe for photo radar. Standard equipment on all V1s, but not activated. To activate, see: <http://www.valentine1.com/lab/MikesLabRpt3.asp>.

Finds all lasers

Valentine One covers all traffic laser. In the U.S., the operating wavelength of traffic laser is 820-950 nanometers.

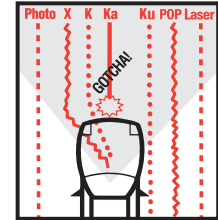

Older detectors find only two or three types of radar.

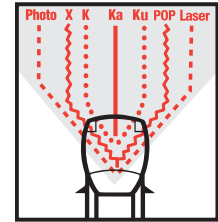

Valentine One® finds all radars, including Stalker.

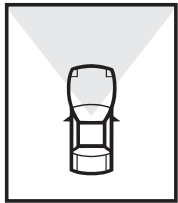

Ordinary detectors scan ahead of your car only.

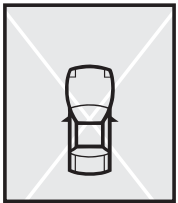

Valentine One® scans all around your car.

Tells Where

Valentine One is the only detector that locates radar. You are vulnerable to radar either ahead of you or behind you. But radar can't get you from the side.



Radar ahead



Radar to the side



Radar behind

Valentine One also locates the laser source, either ahead or behind. Like radar, laser can't get you from the side.

Tells How Many

Valentine One is the only detector that tracks multiple threats (bogeys). How many are out there? Consider:

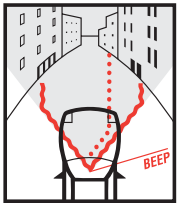

Ordinary detectors give the same warning for one or multiple radar signals.

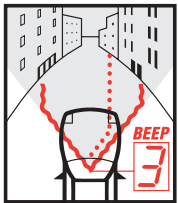

Valentine One® counts threats so you'll never be surprised.

Example 1: Let's say your detector is in full alert, then you see a radar unit. Naturally you assume the radar you saw is the cause of the alert. But what if there's another radar unit just up the road waiting for you?

Example 2: Let's say you're in an alert caused by a known X-band burglar alarm. What if a radar operator, using Instant-on, is simultaneously working the same territory?

In both cases, an ordinary radar detector would set you up for a big surprise because it would lead you to believe that only one bogey was out there. Valentine One is your insurance against surprises. It always tells you how many.

Anything less is not Full Coverage!

What's Included

With Valentine One Radar Locator:

1. Valentine One Radar Locator
2. Windshield mount
3. Visor mount
4. Lighter adapter
5. Power cord, coiled
6. Power cord, straight
7. Spare suction cups
8. Direct-wire power adapter
9. Wiring-harness connector
10. Owner's Manual
11. Spare fuses

With the Concealed Display:

(optional at extra cost)

1. Straight power cord, 8-foot
2. Straight power cord, 3-inch
3. Display-module backplate, for mounting
4. Dual Lock® Fasteners

With the Remote Audio Adapter:

(optional at extra cost)

1. Power cord, straight

Starting Up

Valentine One has been designed for easy operation. Please follow these steps:

1. Mount Valentine One so that it has a clear view ahead and behind your car, using one of the mounts supplied. For more information on mounting, see pages 17-18.
2. Plug lighter adapter into lighter socket and connect power cord to **Main** jack. For more information on power connections, see pages 19-20.
3. Switch power "on" and adjust volume. For more information on control settings, see pages 14-16.
4. Enjoy Full Coverage radar and laser protection. For more information on interpreting warnings, see pages 4-13.

What you should know about radar

How Traffic Radar Works

Traffic radar uses a radar beam to measure speed. Think of the beam as a searchlight. It's invisible because it's made of microwaves instead of light, but otherwise it acts very much like a light beam. It travels in straight lines. It's easily reflected. It scatters as it is passed through dust and moisture in the air. And — this is essential — it has to hit your car before it can determine your speed.

Radar can't see around corners or through hills. It can't see you when you are behind another vehicle. When in the clear, how strongly your vehicle reflects determines how far the radar can read your speed. Generally, larger vehicles reflect more strongly than smaller vehicles. Trucks are "visible" on radar farther away than cars.

The principle on which radar operates is absolutely reliable. Radar equipment, on the other hand, is only as good as the quality of its design and manufacture. Traffic radars tend to be unreliable. They're cheaply made and therefore vulnerable to many interferences that cause false readings. And, compared to the military and weather radar which have rotating antennas, traffic radars are vastly simplified. This simplification means that traffic radar cannot tell one car from another. The operator has to do that, and since the operator can't see an invisible beam any better than you can, he frequently doesn't know which vehicle's speed is being read. This is a source of many undeserved tickets.

How Radar Detectors Work

A radar detector works like a radio tuned to microwave frequencies. Valentine One is an extremely sensitive radio, and it's tuned exactly to the frequency bands used by all traffic radar in the U.S. — X band, K band, Ka Band, which includes photo. Moreover, it has two antennas, one aimed forward and one rearward, so that it can locate the radar.

Because Valentine One is so sensitive, it can easily find radar from the scattering of the beam, and it can find these scatters a long time before the actual beam hits your car. The only exception is Instant-on radar.

How Instant-on (Pulse) Radar Works

As a defense against detectors, many radar units can be operated in the Instant-on mode, also called the Pulse mode. This means the radar is in position, but it is not transmitting a beam. So it cannot be detected. When the target is within range, the radar operator switches on the beam and the radar calculates the speed, usually in less than a second. This calculation happens too quickly for the target (you) to respond in time.

Still, you can defend against Instant-on by recognizing it when the operator zaps traffic ahead of you. Valentine One's great sensitivity — and your attention to the nuances of its warnings — gives you at least a sporting chance.

The Difference Between X Band and the K Bands

X-band alerts ("Beep") are often found at long distances. K and Ka bands are usually detected at closer range, and alerts on those frequencies are much more likely to be radar. So Valentine One makes a different sound ("Brap") to warn you of these more urgent threats (bogeys).

What are False Alarms

Since all radar detectors are simply radios tuned to the microwave frequencies used by traffic radar, they automatically sound their alert whenever they encounter signals on those frequencies.

The problem is, other devices that are not radar are also operating on radar frequencies. A detecting radio must respond to them too. Every response indicates a threat, a bogey. How can you tell the difference between radar and what people commonly refer to as false alarms? Your judgment is the only way. But here are the basics:

- **X band:** A catch-all band, still used regularly in some areas by traffic radar, but heavily populated by sensors for supermarket automatic doors and other nuisance signals. In shopping areas, expect door sensors. But know the territory. Unless you're sure that X band is not used locally for radar, stay alert until you've identified the bogey.
- **K band:** Maybe radar, maybe not. Supermarket door sensors operating on K have recently begun corrupting this formerly reliable warning of radar. Another non-radar source — cheapie radar detectors that pollute by transmitting on K.

Identifying Alarms From Junk Detectors

Here are a few clues for spotting offending detectors. You may get a brief K warning just as you meet an oncoming car. Or a lingering K, nearly constant strength, as you move with traffic. Big hint: a direction change on the Radar Locator as you pass another car. Look for a detector in the windshield. But stay alert until you know for sure. See page 16 for what “Dee-Dah-Do” tone means.

- **Ka band:** Watch out! Most of the new-tech radars operate on Ka. Expect some contamination from cheapie detectors, just as with K (clues above also apply to Ka). Do not dismiss Ka alerts until you’ve positively identified the source.

How To Identify Bogeys

Look first at the Radar Locator. If it points to the side, the bogey is non-threatening — radar can’t get you from the side. If the Locator points ahead or behind, try for visual identification. And when the Locator changes from Ahead to Beside and then Behind, you can be sure the bogey is safely behind you.

Check the Bogey Counter. Because many non-radar devices occur in multiples. For example, most microwave door sensors have at least two transmitters (for In and Out). Often such an installation will have multiple doors too, so there will be many transmitters. When you see two or more on the Bogey Counter, and particularly when you see it counting up quickly to four or more, you’ve likely found a nest of door sensors.

Burglar-alarm microwave sensors are often multiples too, because a single transmitter is not enough to safeguard an entire building. But microwaves from alarms are less likely to leak out of buildings. So alarms may appear singly or in low multiples.

Single bogeys must be regarded as threats until you see them or put them safely behind you.

Remember, too, that radar beams are easily reflected. Buildings, overhead signs and passing traffic are all good reflectors. When you have a strong signal from one direction, don’t be surprised if the Radar Locator shows brief flickers from another direction also as you drive by reflectors.

And never forget that a brief alert, acting alone, may be Instant-on radar zapping other traffic.

Finding Radar

On-the-road situations

Valentine One gives you far more information about radar than any radar detector. Still, to achieve the best defense, you must interpret this information correctly. The following examples will help you get maximum protection.

Situation 1: You are driving toward a radar aimed at you.

Your Warning: The Ahead arrow will glow. The Bogey Counter will show 1. You’ll hear a slow Beep for X band or Brap for other radars. As you come close to the radar, the Beeps (or Braps) will become more frequent until they merge into a continuous tone. By this time you should see the radar.

The Beside arrow and then the Behind arrow will glow as you pass the radar.

In this situation, moving radar and stationary radar will give the same alert, except the Beep rate will increase faster with moving radar because the closing speed is greater.

Situation 2: You’re driving on a hilly road. Radar is waiting over the next hill.

Your Warning: Well before you reach the hilltop, the Ahead arrow will glow. The Bogey Counter will show 1. You’ll hear a slow Beep or Brap, and the rate will increase very quickly as you near the hilltop. As soon as you can see over the hill, you will probably spot the radar.

Situation 3: You’re driving on a curvy road. Radar is waiting around the next curve.

Your Warning: The Ahead arrow will glow (because the radar is forward, not to the side, of your car). The Bogey Counter will show 1. You’ll hear a slow Beep or Brap, and the rate will increase very quickly as you turn the corner. You should see the radar as soon as you’re around the corner.

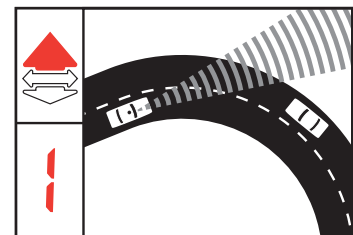
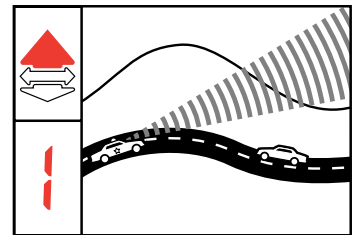
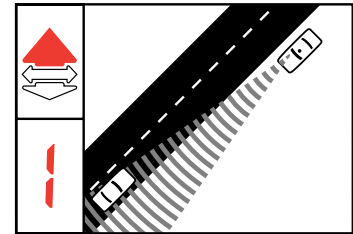

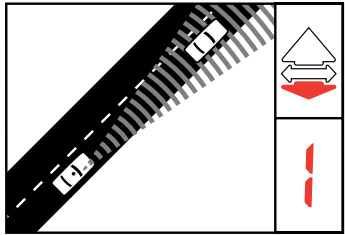

Situation 4: You're driving down the highway and moving radar is coming up behind you.

Your Warning: The Behind arrow will glow. The Bogey Counter will show 1. You'll hear a slow Beep or Brap, and the rate will increase *very* slowly. This sort of alert could last for miles because the closing rate is just a few mph. Finally, if you watch your mirrors, you'll see the radar. To mute the audio at any time, press the Control Knob.

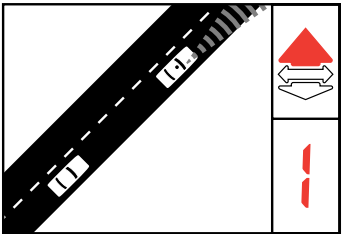

Situation 5: You're driving down the highway and closing on a moving radar ahead of you that's going in your direction.

Your Warning: The Ahead arrow will glow. The Bogey Counter will show 1. You'll hear a slow Beep or Brap that increases *very* slowly. As in Situation 4, your closing rate is very slow, so this alert could last for a long time.

Whenever you encounter an alert that lasts for an abnormally long time, it's probably radar moving along at about your speed. To mute the audio at any time, press the Control Knob.

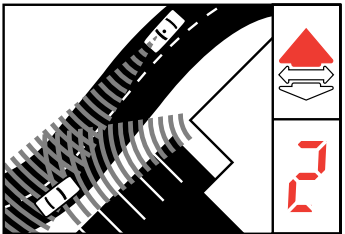

Situation 6: You're driving a route where you expect a burglar alarm, but this time there's radar hiding under the cover of the normal alert.

Your Warning: The Ahead arrow will glow. You'll hear the usual Beep or Brap if you detect the burglar alarm, possibly (but not necessarily) a different sound if the radar is detected first. But when you hear the Bogey Lock ("Dee-Deet") warning, that's a sure indication that this situation is more threatening. The Bogey Lock warning is given whenever Valentine One locks onto an additional threat. In this case, the Bogey Counter will show 2, confirming the second threat. If the radar is X band, same as the burglar alarm, you will hear a slow Beep; it may strengthen faster than normal. If the radar is on one of the other frequencies, the audio will correspond to the bogey that the computer has determined to be most dangerous.

The key thing to remember is, any time you detect more bogeys than normal, watch out.

Situation 7: You're driving through a metro area with the usual number of burglar alarms and microwave door openers.

Your Warning: Because these signals are usually weak, you'll get slow Beep or Brap (if you hear Bra-Brap, the warning for Ka band, it's probably radar). The Ahead arrow will quickly pass to the side. Or your first alert may be to the side. These alarms are usually located well off the road.

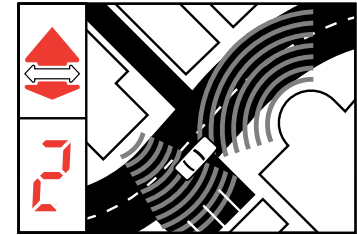

You may also encounter overlapping alarms. During an alert, you'll hear Bogey ("Dee-Deet") Lock each time an additional bogey is detected. The Bogey Counter shows the total, which, in the case of overlapping alarms, will be 2 or more. If they are in different directions, more than one direction arrow will glow. When multiple directions are being monitored, the computer will decide which is most dangerous and that one will be indicated by a flashing arrow. The audio warning will correspond to that bogey.

The key thing to remember about non-radar alarms on X band is this: they're weak and they pass to the side quickly. If you find a strong one Ahead, it's probably radar.

You can minimize the annoyance of these X-band alarms by selecting Logic® or Advanced-Logic® modes. See Controls & Functions (pages 15 and 16).

Situation 8: You're driving down the highway and Instant-on radar is operating nearby.

Your Warning: The first thing you'll notice will be "Beeeee", or "Braaaaa" because the radar encounter will start instantly at high strength. If the radar is ahead, then the Ahead arrow will glow. Probably the radar is aimed in your direction, but maybe not. It might be aimed the same way you're going, zapping oncoming cars as they approach and ready to shoot you in the back after you've passed. In either case, watch out.

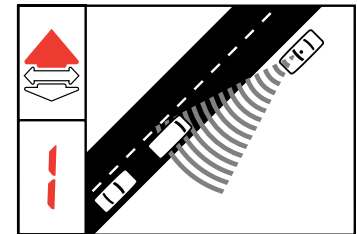

If the Behind arrow glows simultaneously with the "Beeeee" or "Braaaaa", probably you are being shot in the back.

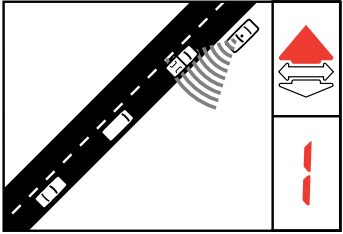

Situation 9: You're driving down a highway and Instant-on radar — a long way ahead — is zapping traffic as it passes.

Your Warning: The Ahead arrow will glow. The Bogey Counter will show 1. You'll hear a very slow Beep or Brap that will last just 3-5 seconds. Then the alerts ends.

What happens next depends on traffic and terrain. If there's light or medium traffic between you and the radar, you'll hear the same pattern again, maybe repeated several times, as the radar zaps each car ahead in turn. If you hear this pattern, watch out.

If there's no traffic within sight ahead, watch out, because you could be next.

With ordinary detectors, short, weak alerts are usually shrugged off as false alarms, leading the motorist to drive right into an Instant-on trap. The Radar Locator is critical to your defense in this circumstance. If it points off to the side, the bogey is not a threat. But if it points ahead, watch out.

Laser Warning

How To Mount

Follow mounting instructions on pages 17-18. Laser Warning requires more care in mounting. Remember that laser is infra-red light, and the light path to Valentine One could be blocked by certain materials that are transparent to radar. Consider:

1. Important: position Valentine One so that it's level and pointed straight ahead.
2. Avoid locations blocked by wipers or windshield stickers. Make sure glass is clean.
3. Some windshields have a dark tint band across the top. Avoid mounting behind that band.

How To Recognize A Laser Encounter

On laser contact, your warning will be:

1. European two-tone siren warning sound.
2. When Ahead-arrow lights, laser is ahead. When the Behind-arrow lights, laser is behind.
3. Bogey counter displays three horizontal bars.
4. Strength-indicator bar graph shows full strength.
5. LED indicates laser.

NOTE: The same visual warnings will be seen on the optional Concealed Display.

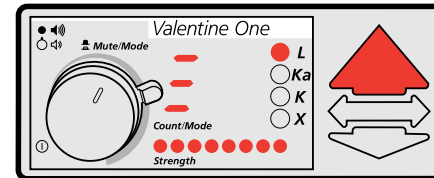

Indicates laser ahead

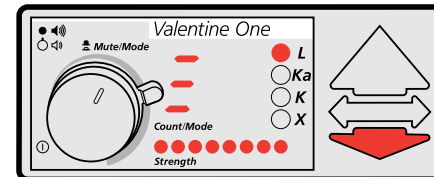

Indicates laser behind

What you should know about laser

How Traffic Laser Works

To measure speed, traffic laser sends out a beam of pulsed infrared light. The beam is tightly focused: at a range of 1000 feet, it's only about four feet wide.

Infrared is invisible to the naked eye — the operator can't see it and neither can you. But it is light and it behaves accordingly. It travels in straight lines. And it's easily reflected.

Traffic laser works as a rangefinder. It sends a pulse, then waits for the reflection from the target car. From the time needed for the pulse to go out and back, and from the speed of light, it calculates distances to the car. These pulses are sent frequently, up to 500 times a second. The changing distance to the target over time is speed.

Laser can't see over hills or through opaque objects. The laser beam must hit your car directly, line-of-sight from the laser gun, to measure speed. Under ideal conditions, it can read speed in less than one second.

The pencil beam means that, in operation, laser is very different from radar. Radar cannot single out one vehicle in a pack, so the speed reading is usually attributed to the leader. The narrow laser beam reads only the vehicle it strikes.

How Laser Detectors Work

A laser detector is an electronic sensor calibrated for the infrared wavelength used by traffic laser. It is extremely sensitive. And it responds in as little as .006 seconds.

It should be mounted inside the car with the sensor facing through the glass toward the laser. When the beam, or scatter from the beam, strikes the detector, it warns instantly.

Finding Laser

How It Operates

Laser's narrow beam imposes significant limits on its use. It must be deliberately and carefully aimed. The operator can't be moving. He must have a clear shot, preferably not through glass.

So laser traps are always ambushes. The operator lies in wait. As with radar, he can't read speed from the side. He must have oncoming and departing traffic. Look for a cruiser angled to the road, or broadside. Watch overpasses and entrance ramps. He will likely rest the laser gun on a partially-down side window to steady his aim. He will pick off traffic as it comes. Or goes.

Our breakthrough Compound Parabolic Concentrator enables Valentine One to achieve both wide-angle coverage and unmatched sensitivity. Even so, the over-hills and around-curves warning you expect from a radar detector is not possible with laser. A laser warning requires immediate response.

Details To Remember About Laser

1. There is no moving laser.
2. All laser encounters are like Instant-on radar; virtually no advanced warning.
3. Laser alarms are rare with the Valentine One, so be prepared to respond.

Laser False Alarms

1. Red neon, from stores and occasionally from brake lights of other cars (example: Chevy TrailBlazer, GMC Envoy, Olds Bravada and Buick Rainier), can imitate the characteristics of speed laser.
Solution: Move away from source.
2. The electrical systems of some cars generate electromagnetic interferences, triggering laser alerts.
How to test: Try V1 in a different car.
Possible solution: Try relocating detector within the interfering car; also, your dealer may have a factory fix.
3. Adaptive cruise control systems using laser may cause laser alerts.
Solution: Switch to normal cruise control.

Controls & Functions

How Valentine One Works

Everybody wants Full Coverage against radar; nobody wants to go to college to learn how to use his new radar detector. So I've worked extra hard to make Valentine One logical. It's far easier to operate than many ordinary detectors, yet it tells you far more about radar.

A New Way to Set Loudness

Valentine One has two controls for loudness so you can take complete control of sound. The Control Knob sets what I call "initial" volume. This is the loudness you will normally hear on initial radar contact. Once you're aware of the threat, you can drop to a quieter, reminder sound which I call "muted" volume. Just press the Control Knob. This muted volume is adjusted by the lever behind the knob. How loud do you like your reminder? The choice is yours.

Push To Mute

During any alert, press the Control Knob. Audio volume will drop to the muted level.

What Long-Gradient audio does for you

Valentine One's audio warning indicates radar strength. It gives a very slow Beep for X band (Brap for K band, Brap-brap for Ka band) when it encounters weak radar, then quickens as radar strength increases, and becomes a continuous tone about the time you're in range. This long gradient, from slow Beep to continuous tone, makes it easy to estimate radar proximity, which is very important during brief Instant-on encounters. In the case of multiple bogeys, the audio warning will always monitor the greatest threat.

What the Bogey Counter does for you

Every alert, until you've positively identified the source, is an unknown, a bogey. But an alert may consist of more than one bogey. There could be many. Let's say you drive by a burglar alarm on the way to work every day that causes an alert. Then one day you pick up an additional bogey. This new bogey could be radar hiding under cover of the burglar alarm, picking off the unwary. You must assume each alert is radar until you've identified the bogey. For more information see pages 5-6.

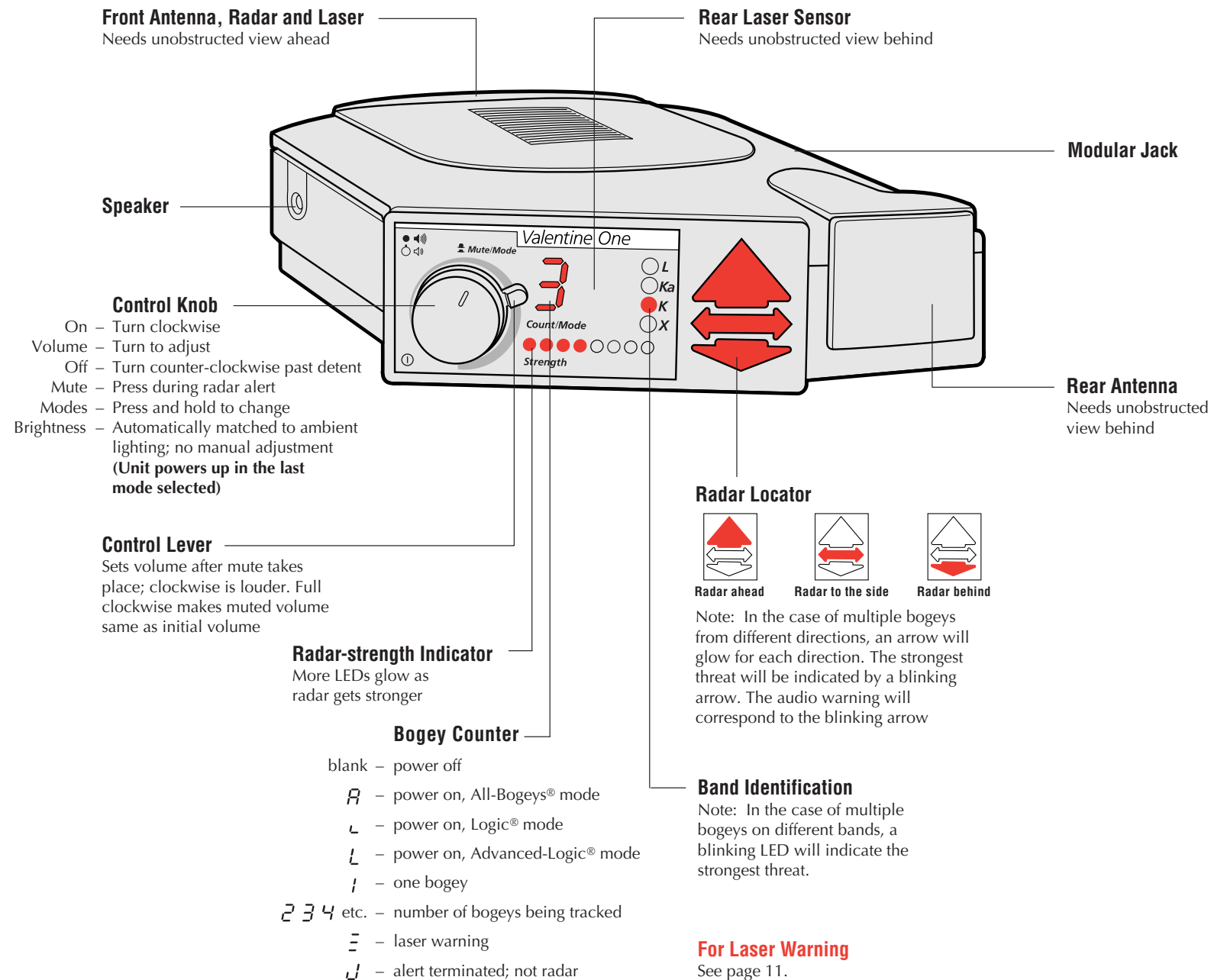

Computer Modes: A new way to interpret alarms

In the All-Bogeys® (A) mode, all bogeys will be reported as soon as they are detected. Use your judgment to decide whether or not they are threats.

In the Logic® (L) and Advanced-Logic® (L) modes, you are deferring to the internal computer which will use its own logic to screen bogeys before reporting them to you.

In Logic, X-band bogeys the computer judges to be non-threatening will be reported at the "muted" volume. If they become threatening, the audio warning will upgrade to the "initial" volume before you are within radar range.

In Advanced-Logic, X-band bogeys that the computer has reason to believe aren't radar will not be reported at all. One exception: To be failsafe, the computer will always pass extremely strong signals along for your judgment. This mode is particularly useful in metro areas.

The computer is smart: It never operates the receiving circuits at less than maximum sensitivity and it knows that Instant-on is a greater threat than ordinary radar. So it will always warn you immediately at the "initial" volume when those radars are detected, no matter what mode you've selected.

To change modes, press and hold the Control Knob for one second.

What the Bogey Lock tone means

Valentine One is designed to track multiple threats. During an alert, when Valentine One locks on to an additional bogey, it notifies you with the Bogey Lock tone ("Dee-Deet"). This sound will never be heard at any other time, not even during the power-on ritual. Whenever you hear this sound, it means that another bogey has been detected and is being tracked. The bogey counter shows the number of bogeys being tracked at that time.

What the "Dee-Dah-Doo" Tone means

Valentine One is designed to recognize — and ignore — phony radar signals from poorly-designed detectors. Occasionally a false alarm will be started before verification is certain. If it then determines the source is a junk detector, it will notify you it is retracting that alert with a "Dee-Dah-Doo" sound. A flashing J (J) indicating "junk" will appear in the Bogey Counter.

Where to mount

Valentine One works best when mounted high in the windshield, and toward the center between the windshield pillars. Use your choice of windshield or visor mounts.

- When properly mounted, the **front antenna** will look forward through the glass. It must have an unobstructed view. Don't put it behind the parked windshield wipers, or directly behind an in-glass antenna. Don't position it so that it "looks" into the rearview mirror.
- The **rear antenna** will look rearward, between passengers and out the rear glass. It, too, must have an unobstructed view.
- **Detector performance is enhanced** by a high mounting position. Two reasons. For radar, a longer sight line to the horizon always helps. For laser, moving away from the hood and its sun reflections helps a lot.

IMPORTANT NOTE: Windshield heaters such as Ford's InstaClear® block radar from passing through the glass (look for a brown tint). So do **solar barrier** windshields of the type used on GM Venture-Montana-Silhouette-Trans Sport minivans and on some imported luxury sedans (look for a reddish or copper tint). Same for mirrored sun screens. Detector performance will be greatly reduced when V1 is mounted behind such metallic films.

SAFETY WARNING: Because a detector on a windshield mount or visor mount is not permanently attached to the car, it could come loose in a crash, possibly causing injury. Also, a passenger may move forward on impact and contact the detector. Keep these possibilities in mind when you mount your Valentine One.

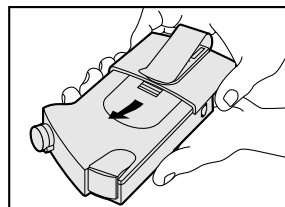

Visor mount slides on from front.

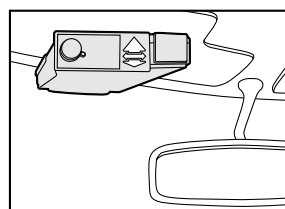

Install near center of windshield.

How to mount

Mounting on visor

1. Slide visor mount on to Valentine One.
2. Clip to visor near center of windshield.
3. Adjust visor angle so unit is approximately level.
4. Connect power cord and plug into lighter socket.

Mounting on Windshield

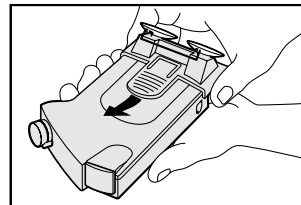

Windshield mount goes on from front.

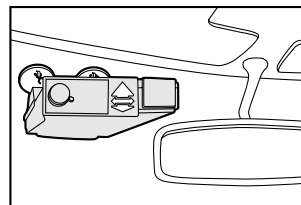

Install near center of windshield.

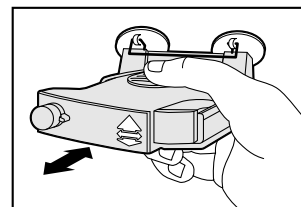

Unit slides in mount to adjust angle.

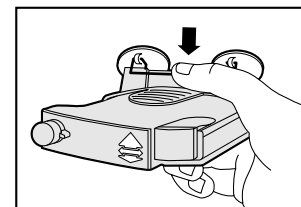

Press bar to loosen suction cups.

1. Slide windshield mount onto Valentine One.
 2. Press suction cups to glass near center of windshield.
- Hint: A. If suction cups don't stick, try rubbing your thumb a few times around the face of the cup with a circular motion.
- B. If suction cups are distorted or misshapen, hold under hot tap water for 15-30 seconds.
3. To adjust angle, press Thumb Tab and simultaneously slide unit within mount until level position is achieved.
 4. Connect power cord and plug into lighter socket.
 5. To release from windshield, gently press down the wire Release Bar connected to both suction cups.

INSTALLATION: Direct-wire Power Adapter

An adapter has been provided so that you can wire Valentine One directly into your car's electrical system. If you are unfamiliar with automotive electrical systems, see a mechanic or car-stereo installer:

1. Valentine One works only with negative ground electrical systems. If your car is old, or is an unusual brand of import, make sure it's negative ground.
2. Select a "switched" wire, i.e., one that's off when the ignition is switched off, and has 12 volts when the ignition is switched on.
3. Position wiring-harness connector around "switched" wire and squeeze with pliers to install.
4. Plug red wire from Direct-wire Power Adapter into wiring-harness connector.
5. Make ground connection by clamping the end of the black wire under any grounded screw.
6. Plug power cord from Valentine One into the modular jack labeled "Main Unit" on the Direct-wire Power Adapter.

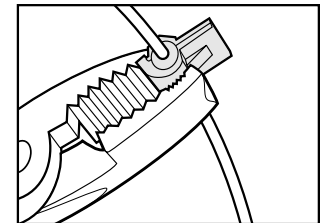

Pinch connector around power wire.

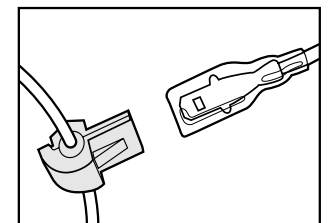

Connector plugs into red wire.

Changing the Direct-wire Power Adapter Fuse

Fuse holder is in-line with the power wire (red) to the adapter. Unscrew fuse holder to change fuse. Use a 1 amp. 5mm x 20mm fuse (to change Lighter Adapter Fuse, see page 22).

Concealing the Power Cord

For a neater installation, you may wish to route the power wire out of sight. Some knowledge of automotive electrical systems and of interior-trim removal is necessary to do it yourself. If you have doubts, see a mechanic or car-stereo installer.

Making your own Power Cord

Valentine One uses standard RJ-11 (modular) telephone connectors. You can use any telephone cable (the one that runs from the wall jack to the phone) for a power cord. Complete cables are available in many lengths at electrical or building-supply stores.

You can also make your own power cord using bulk phone cable cut to whatever length you choose. To attach the RJ-11 connectors, you will need a special attaching tool. Bulk phone cables, loose connectors, and the attaching tool are available in most electrical or building-supply stores.

NOTE: The sequence of wires must be reversed from one end to the other.

Concealed Display

The Concealed Display Kit (optional) makes Valentine One less noticeable to others outside your car. It allows you to operate Valentine One with its lights blacked out, yet have a fully operational display module down low in the car where it's not visible outside.

Concealed Display Module

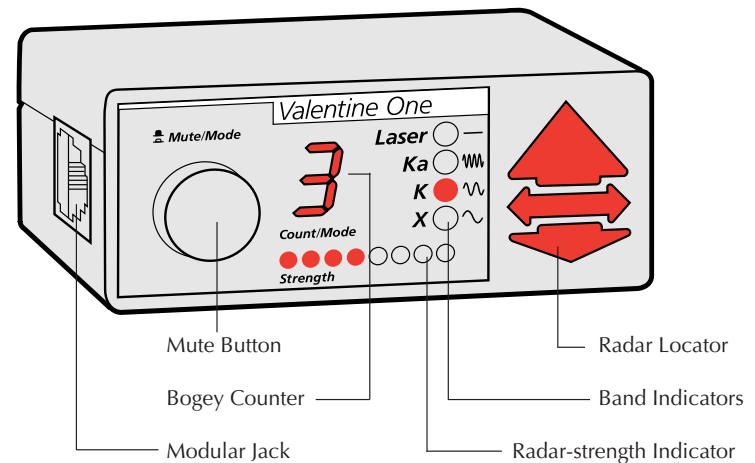

Dimensions: 1.0-in. H x 2.5-in. W x 1.2-in. D

Lighter Adapter

Articulated Bracket ▼

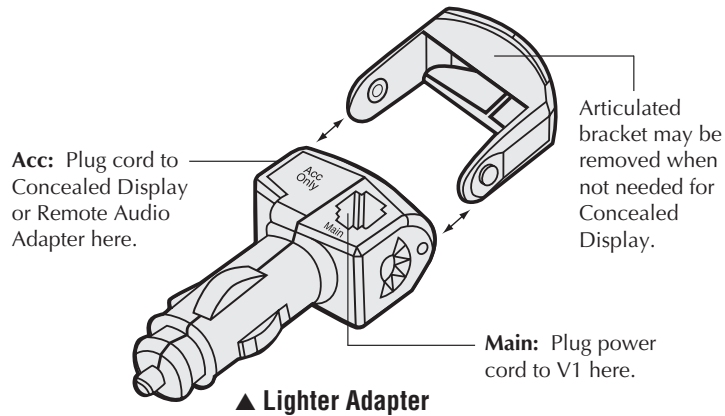

Changing the Lighter Adapter Fuse

Slide Fuse Ejector along its channel to eject fuse. A firm push will be needed. Replace with 2 amp, Mini Blade Fuse.

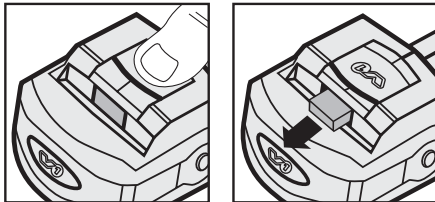

Push Fuse Ejector towards fuse to eject.

INSTALLATION: Using Lighter Adapter

1. Slide Lighter Adapter with Articulated Bracket into cavity on back of Concealed Display Module.
2. Connect **Acc** on Lighter Adapter to Concealed Display with 3-inch cord.
3. Adjust angle on Lighter Adapter, then insert Lighter Adapter into lighter socket.
4. Run the power cord from the **Main** jack on the Lighter Adapter to Valentine One.
5. To operate, adjust Control Knob and Control Lever on Valentine One to your desired settings.

IMPORTANT NOTE: Do not use Direct-wire Power Adapter with Lighter Adapter.

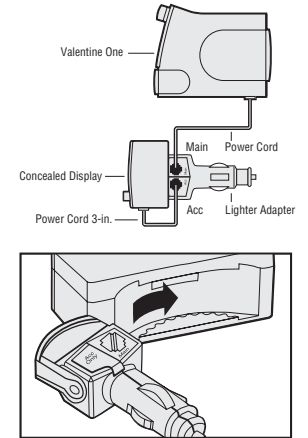

Lighter Adapter slides into place.

INSTALLATION: Using Mounting Plate

1. Slide Mounting Plate into cavity on back of Concealed Display Module.
2. If using Dual Lock®, adhere one square of Dual Lock® to the recess on the back of the Mounting Plate. Adhere mating Dual Lock® square to desired mounting location.
3. If using the Direct-wire Power Adapter, follow instructions on page 19.
4. Run a power cord from the **Acc** jack on the Lighter Adapter, or the Accessory jack on the Direct-wire Power Adapter, to the Concealed Display Module.
5. Run a power cord from **Main** jack on the Lighter Adapter, or the Main Unit jack on the Direct-wire Power Adapter, to Valentine One.
6. To operate, adjust Control Knob and Control Lever on Valentine One to your desired settings.

IMPORTANT NOTE: Do not use Lighter Adapter with Direct-wire Power Adapter.

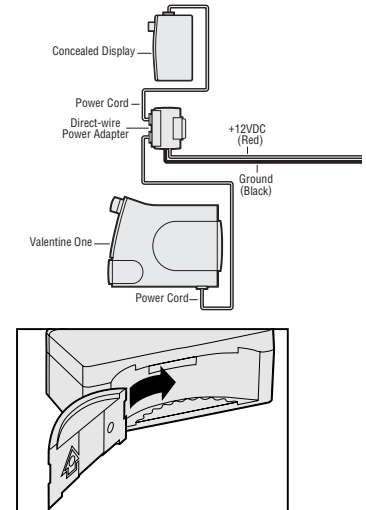

Mounting plate slides into place.

Remote Audio Adapter

This module adapts Valentine One for the following installations:

- Provides remote control of on/off, volume, muted volume, muting, and computer mode.
- Provides remote speaker.
- Provides headphone mini jack 3.5mm (1/8").
- Provides micro jack 2.5mm (3/32") for additional remote speaker.
- Caution — Improper installation may damage equipment. Refer to www.valentine1.com for further information.

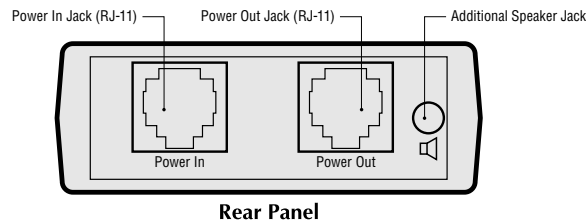
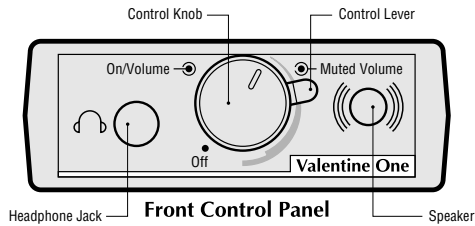

Dimensions: 0.87-in. H x 2.45-in. W x 2.00-in. D
NOTE: Valentine One and accessories are not waterproof.

Install according to one of the following diagrams:

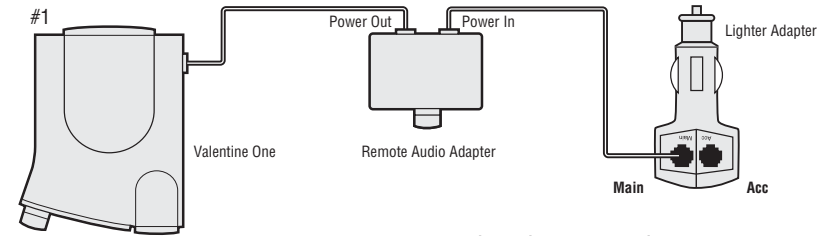

- Remote Audio Adapter controls main unit power.

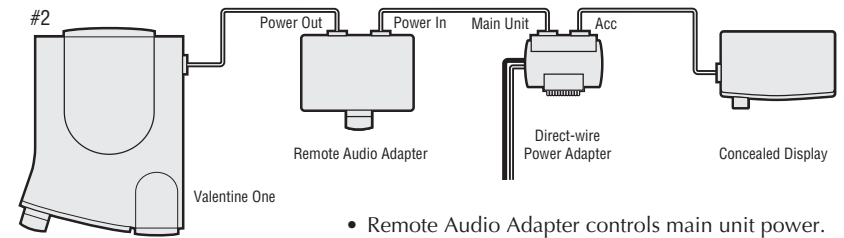

- Remote Audio Adapter controls main unit power.

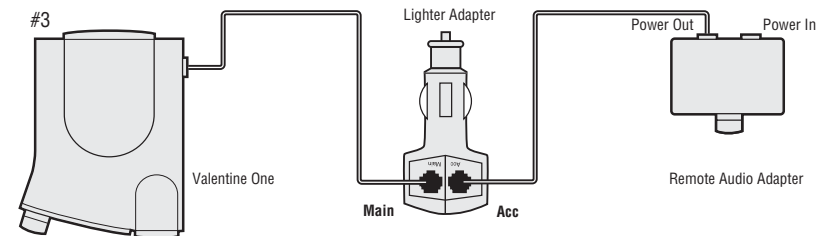

- NOTE: Remote Audio Adapter does NOT control power to the main unit.

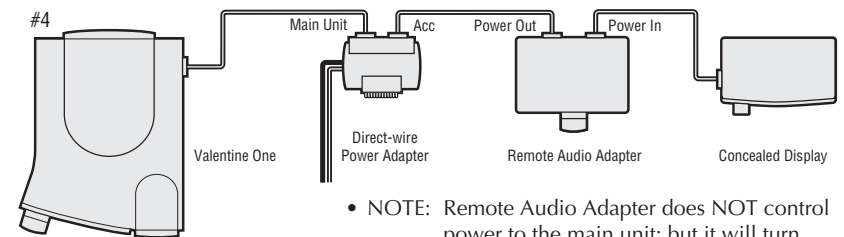

- NOTE: Remote Audio Adapter does NOT control power to the main unit; but it will turn the Concealed Display off and on.

POP Mode

How the POP Mode Works

The POP Mode is a feature of certain radars made by MPH Industries. Its only purpose is to defeat radar detectors. It works by transmitting radar in a short burst — only 67 milliseconds (that's 0.067 seconds).

What you should know about POP Mode

It is inaccurate. In order to outfox detectors, MPH Industries has pushed the technology outside the accepted principles of engineering. And the company admits as much when its Operation and Service Manual advises users as follows:

“A note of caution: Information derived during the POP burst is non-evidential... Citations should not be issued based solely on information derived from the POP burst.”

Nonetheless, POP Mode is a reality and it will be used at the discretion of individual enforcers.

Valentine One has full-time POP Protection

There is nothing you must do to activate POP coverage. It's built in, and it operates full time. It covers POP on two bands — specifically the MPH Industries models Bee III and Enforcer on both K and Ka.

What the “Dee-Dah-Doo” Tone means

Valentine One is designed to recognize — and ignore — phony POP signals transmitted by poorly-designed detectors. Occasionally a false alarm will be started before verification is certain. If it then determines the source is a junk detector, it will notify you it is *retracting* that alert with a “Dee-Dah-Doo” sound. A flashing J (J) indicating “junk” will flash briefly in the Bogey Counter.

Troubleshooting

| Problem | Cause | Solution |
|---|---------------------------------|--|
| Seems dead, no display or audio. | No power. | <ol style="list-style-type: none">1. Check power-cord connections. Check fuse in lighter adapter (Is it in place? Is it blown?) Pages 19, 22.2. Check contact of Adapter in lighter socket.3. Make sure power is available at lighter socket. Does the lighter work? If not, check fuse in car lighter circuit.4. Try another power cord.5. Make sure the power cord to V1 is plugged into the Main jack of the Lighter Adapter.6. Check pins of V1's power jack (bent?). |
| Sounds the power-on audio when you go over a bump. | Bad power connection. | <ol style="list-style-type: none">1. Make sure Lighter Adapter has good electrical contact.2. Check condition of power cord.3. Lighter socket may be faulty (common in rental cars). |
| Alerts when you use vehicle accessories or turn signals or brakes, etc. | Electrical problem in your car. | <ol style="list-style-type: none">1. See your mechanic. |
| Weak or no radar detection. | Possible installation problem. | <ol style="list-style-type: none">1. Make sure front and rear antennas are unobstructed.2. Make sure V1 is approximately level.3. See page 29. |

Troubleshooting

| Problem | Cause | Solution |
|---|---|---|
| Weak detection in front but good behind. Directional arrows are inaccurate. | Possible installation problem. | 1. Make sure your windshield is not covered with a metallic film. Windshield de-icers such as Fords InstaClear block radar. So do some sun-blocking films and some new-car glass options. |
| Numerous false alerts. | Other super-heterodyne radar detectors mounted in the same vehicle. | 1. Do not operate V1 in close proximity to other detectors. |
| Display is "frozen" with all lights on. | V1 is inadvertently in the program mode. | 1. Replace power cord. If using Concealed Display, make sure Mute button is not depressed. |
| Unusual characters in display (R, L, L). | V1 is in mode unfamiliar to you. | 1. Press and hold Mute button to change modes. See pages 14-16. |
| Can't change modes. | Faulty power cord. | 1. Replace power cord. |
| False X-band alert from rear, either continuous or random intervals. | Cell-phone interference. | 1. Relocate V1. 2. Change modes to Advanced-Logic (L). 3. Change cell-phone service provider. |
| False laser alerts, either continuous or random. | Laser cruise control; in-dash navigation screen. | 1. Switch to normal cruise control instead of laser. 2. Relocate V1 so laser sensor is not pointed toward navigation screen. |

Doubts . . . Maybe it's not working right

You bought Valentine One because you wanted the best radar protection. When you're really concerned about having the best, doubts come easily . . . "Is it really working right?" . . . "It didn't give much warning that time. Is it dying on me?"

Such doubts are not easily resolved by a few paragraphs in a manual. Still, radar behaves according to laws of physics. So does Valentine One. There are reasons for everything that happens. Please consider the following possibilities.

1. If you didn't get a radar alert from a radar car, was the radar turned on? Remember that Instant-on doesn't send out a detectable beam until it's triggered.
2. There are strong radars and weak ones. If you received a weak alert, could it have been a kind of radar that you're not used to?
3. The radar antenna can be pointed any direction inside the radar car. It doesn't have to point toward the front. Are you sure it was pointed at you? If it's pointed away, its strength as you approach is much less.
4. Traffic, particularly trucks, between you and the radar can block the beam. Were you blocked?
5. The radar beam travels in a straight line. Was there a hill or building in the way?
6. Rain, moisture, or dust in the air can shorten radar range. Could this be the reason for the weak alert?

Valentine One was designed to provide you with security. We don't want you to have doubts. If you still feel that your unit is not operating properly, call us at 1-800-331-3030. You can discuss your doubts with a technical expert who'll help you decide if your unit should be sent in for service.

Service

If your Valentine One needs repair:

Before sending your Valentine One back to us for service, please check TROUBLESHOOTING on page 27-28.

If it's completely dead, make sure it's connected to a reliable power source. Try another car.

If it still fails to function, follow these instructions to obtain factory service.

Where to ship:

Return your Valentine One, both power cords and lighter adapter (don't send the mounts) to:

Valentine Research
Customer Service
10280 Alliance Road
Cincinnati, Ohio 45242

How to ship:

Ship your unit prepaid and *insured*, in its original packaging or something equally protective. You are responsible for your Valentine One until it is in our hands, so insist on a proof-of-delivery receipt.

Along with your Valentine One, please enclose the following:

- your name, billing address (for credit cards) and shipping address;
- description of the problem;
- your daytime telephone number; and
- if your Valentine One is out of warranty (older than one year), send \$45 or a credit card number with expiration date to cover cost of diagnosis and repair.

Your Valentine One will be repaired as soon as possible.

For units that have been abused or modified, a repair cost will be calculated based on parts and labor required. You will be contacted if the repair cost exceeds the \$45 basic charge.

Note: We will not repair any Valentine One that has an unreadable serial number.

Prices subject to change without notice.

Specifications

Operating Frequencies: 10.500 – 10.550 GHz (X band)
24.050 – 24.250 GHz (K band)
33.4 – 36.0 GHz (Ka band)
13.400 – 13.500 GHz (Ku band): not used in U.S. —
to activate Ku band, see www.valentine1.com
(Ask Mike, Tech Reports, Report 3), or
<http://www.valentine.com/lab/MikesLabRpt3.asp>.
820-950 nanometers (Laser)

Power Requirements: 11.0-16.0 Volts DC negative ground
225 mA typical standby, 425 mA maximum alarm condition

Dimensions and Weight: 4.5 in. L x 3.6 in. W x 1.0 in. H; 6.4 ounces

Temperature Range: Operating: -20°C to +70°C (-4°F to +158°F)
Storage: -30°C to +85°C (-22°F to +185°F)

Parts & Accessories

The following items are available directly from us: Call toll-free 1-800-331-3030

Concealed Display enables operation of Valentine One with lights being visible to driver only

Remote Audio Adapter enables remote control and audio operation of Valentine One with headphone or additional speaker

Power Adapters

Lighter power adapter powers Valentine One from car's lighter socket

Direct-wire power adapter powers Valentine One directly from car's wiring

Fuses replacement for Lighter Adapter: 2 amp, Mini Blade Fuse (Littelfuse 297002)

replacement for Direct-wire Power Adapter:

1 amp, 5mm x 20mm.

Wiring-harness connector provides simple, safe attachment to ignition wiring using ordinary hand tools

Mounts

Windshield mount mount with patented mechanism for easy one-hand release

Visor mount mount with spring clip for quick installation on visor

Suction cups (4) replacement cups for use with mount

Power Cords

Power cords coiled, 1 ft. stretches to 6 ft.; straight, 8 ft.

Additional Items

Owner's Manual instructions for operation and troubleshooting

Dual Lock® extra fasteners for Concealed Display and power adapter

Limited Warranty

Valentine Research, Inc. warrants the Valentine One Radar Locator™ against all defects in materials and workmanship for a period of **one year** from the date of the original purchase, subject to the following terms and conditions.

This warranty is limited to the original owner, and is **Non-Transferable**.

This warranty does not apply if the serial number or housing of the product has been removed, or if the product has been subjected to physical abuse, improper installation, or modification.

To obtain warranty service, the product must be returned, insured and shipping prepaid, to Valentine Research, Inc., at the address below, in its original packaging or a suitable equivalent, along with a written description of the problem.

Valentine Research, Inc.'s responsibility under this warranty is limited to repair or replacement of the product or refund of its purchase price, at the sole discretion of Valentine Research, Inc.

Valentine Research, Inc. disclaims all other warranties, expressed or implied, including warranties of merchantability and fitness for any particular purposes whatsoever, and no other remedy shall be available, including without limitation, incidental or consequential damages. In no event shall Valentine Research, Inc.'s liability exceed the purchase price of the product in question.

Some states do not allow the exclusion or limitation of incidental or consequential damages of how long an implied warranty lasts, so the above limitations or exclusions may not apply to you.

This warranty gives you specific rights. You may have other legal rights which vary from state to state.

Valentine Research, Inc. wants you to be satisfied with its products. Should you have any difficulties with the operation or performance of your Valentine One Radar Locator, please contact:

Valentine Research
Customer Service
10280 Alliance Road
Cincinnati, Ohio 45242
1-800-331-3030

A Few Things to Remember

1. Valentine One is defined as a radio by the FCC. It receives only. It's a passive device that in no way interferes with the communications or business of others.
2. The Federal Communication Act of 1934 guarantees the right to receive radio transmissions of all types on all frequencies. Traffic radar is not privileged communication: in fact, it's not communication of any sort because no information is conveyed to another party. It is surveillance by radio waves, and that is not protected by any laws.
3. Some states and municipalities have laws prohibiting the use, or the possession, or both, of radar detectors. Please check local regulations before using your Valentine One.
4. Leaving your Valentine One in plain sight in an unattended car is asking for a break-in.

We appreciate your confidence in Valentine Research.

Please drive safely.

For Your Records

| |
|----------------------|
| Serial No. |
| Purchase Date |

Manufactured under one or more of the following U.S. patents:

| | | | |
|---------|---------|---------|---------|
| 6175324 | 5250951 | 5116248 | 4878061 |
| 5917441 | 5206651 | 5083129 | 4631542 |
| 5900832 | 5164729 | 5068663 | D338841 |
| 5856801 | 5151701 | 5020754 | |
| 5852417 | 5146226 | 4994775 | |
| 5300932 | 5125110 | 4973925 | |

Other U.S. patents pending



Hereby, Valentine Research, Inc., declares that this radar detector is in compliance with the essential requirements and other relevant provisions of Directive 1999/5/EC.

Refer to <http://www.valentine1.com/standards> for the Document of Conformity.



This device complies with Part 15 of the FCC Rules. Operation is subject to the following two conditions: (1) this device may not cause harmful interference, and (2) this device must accept any interference received, including interference that may cause undesired operation.

NOTE: The manufacturer is not responsible for any radio or TV interference caused by unauthorized modifications to this equipment. Such modifications could void the user's authority to operate the equipment.

www.valentine1.com



Valentine Research

10280 Alliance Road
Cincinnati, Ohio 45242
513-984-8900
1-800-331-3030